

8 7 6 5 4 3 2 1

F
E
D
C
B
A

F
E
D
C
B
A

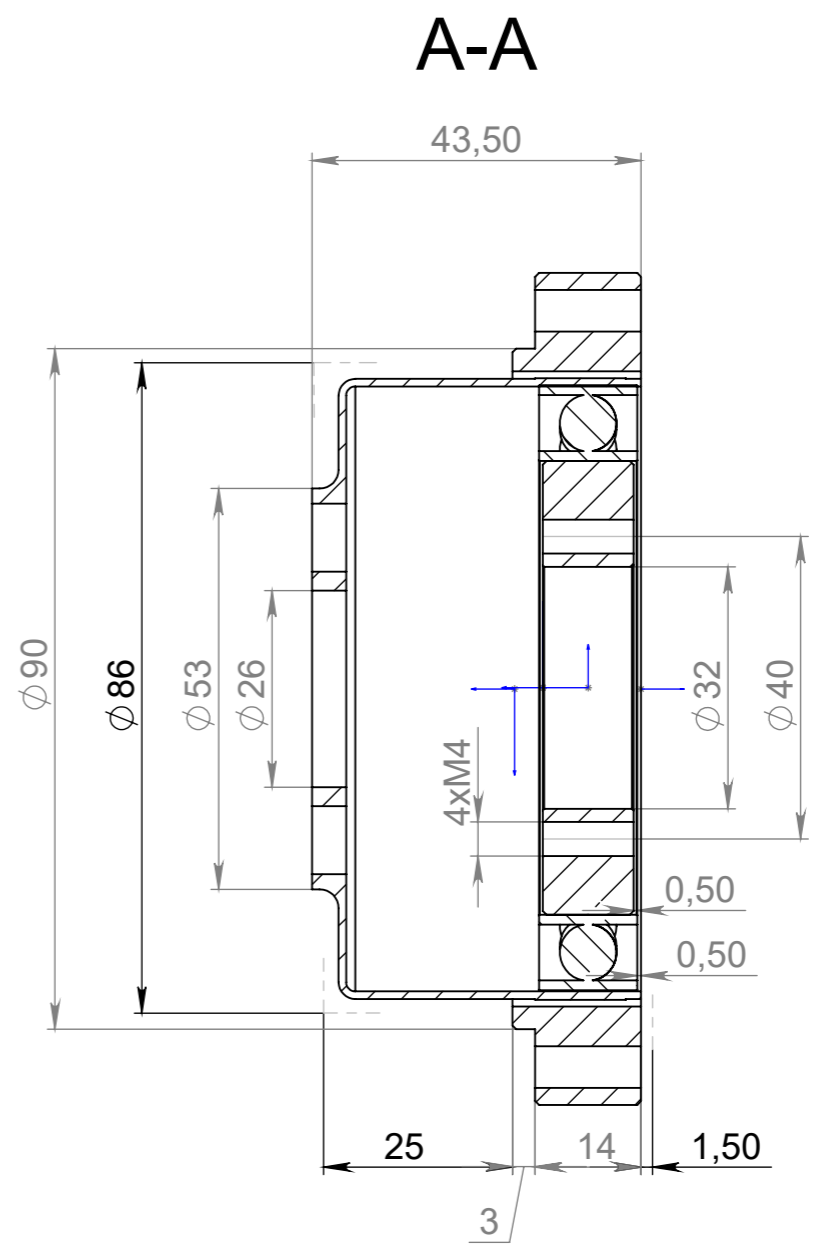
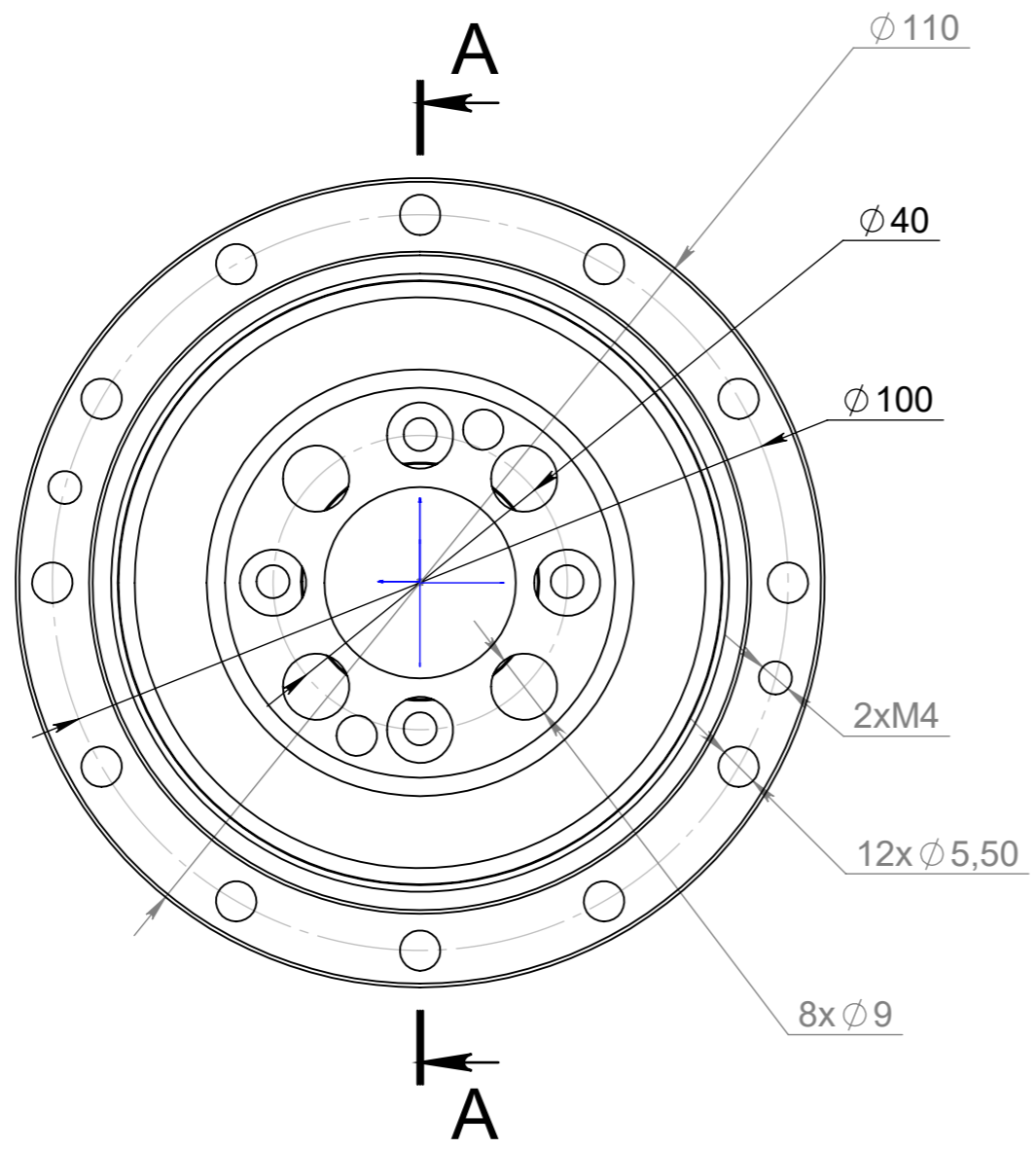

PGK 24-100

8 7 6 5 4 3 2 1